

BOXING MEIXING COMMERCIAL KITCHEN EQUIPMENT MFG.CO,LTD

Baking racks, refrigeration racks, disinfection cabinet racks, dishwasher racks, and oven racks. The protective nets for these racks.



**Sincere cooperation
mutual benefit and win-win situation**



Boxing County Meixing Commercial Kitchenware Co., Ltd. is located in Hubin Town, Boxing County—known as China’s “the capital of commercial kitchen equipment” —good geographical location and convenient transportation

Spanning over 10,000 square meters, we employ a team of more than 300 people and hold a registered capital of over 8 million yuan. As a modern manufacturing enterprise, we specialize in producing a wide range of products, including baking and refrigeration equipment, disinfection cabinets, dishwashers, ovens, and grills. Our portfolio also features racks, protective nets, baskets, drying racks, and tube-fin condensers, all finished with processes like dip coating, electrophoresis, electroplating, and electrolytic polishing.

Since our founding, we have stayed true to the philosophy of “people-first, build strength from within, and project excellence outward” , while upholding the principles of “high positioning, strong foundations, and rigorous standards” . We operate a standardized, systematic management system and are home to a talented team of R&D professionals, supported by cutting-edge production equipment from both domestic and international sources. Our manufacturing processes are continuously refined to deliver high-quality, innovative products that meet evolving market needs. Thanks to our reliable quality, diverse product range, and comprehensive pre-sales, during-sales, and after-sales service, we have earned the trust and loyalty of customers nationwide.

At Meixing, we are a dynamic and growing enterprise. Guided by market demand, driven by innovation, committed to quality, and focused on sustainable growth, we are confident that by upholding the principle of “mutually beneficial cooperation” , we will continue to thrive and achieve even greater success in the future.

Section 1: Baking category-Drying net series

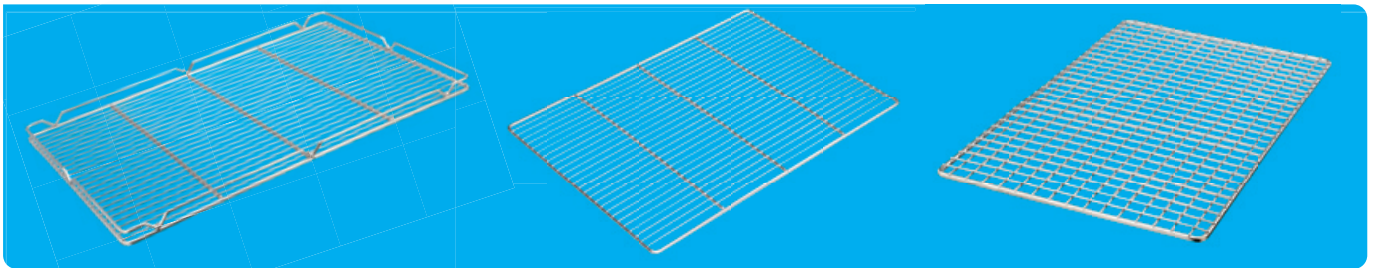

LW01 Stainless steel cooling net
 Size: 600×400×25
 Material: Φ6mm Φ4.5mm Φ2.3mm
 Surface: Electrolytic polishing

LW02 Stainless steel cooling net
 Size: 600×400×8
 Material: Φ6mm Φ2.3mm
 Surface: Electrolytic polishing

LW03 Stainless steel cooling net
 Size: 735×405×11
 Material: Φ8mm Φ3mm
 Surface: Electrolytic polishing

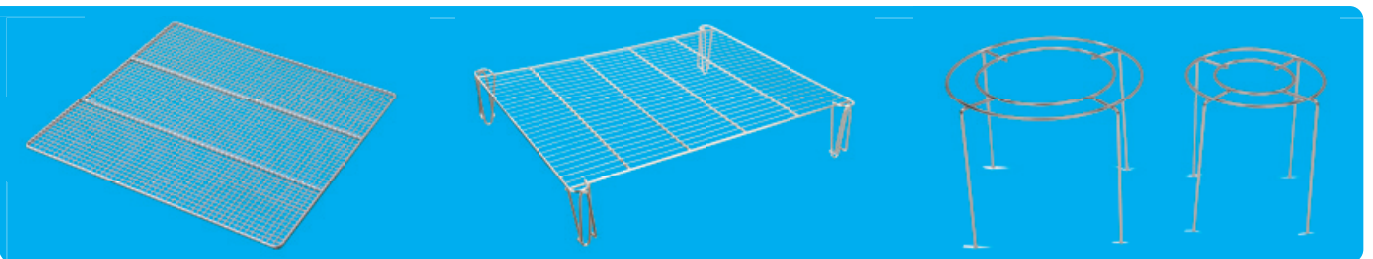

LW04 Stainless steel cooling net
 Size: 605×605×8
 Material: Φ6mm Φ2.3mm
 Surface: Electrolytic polishing

LW05 Combination frame drying net
 Size: 510×625×135
 Material: Φ5mm Φ3mm
 Surface: Electrolytic polishing

LW06 Big cake rack: 178×140
Small cake rack: 125×140
 Material: Φ3mm
 Surface: Electrolytic polishing



LW09 Bag drying rack
 Size: 490×500
 Material: Φ4.5mm Φ4mm Φ2.5mm
 Surface: Electrolytic polishing

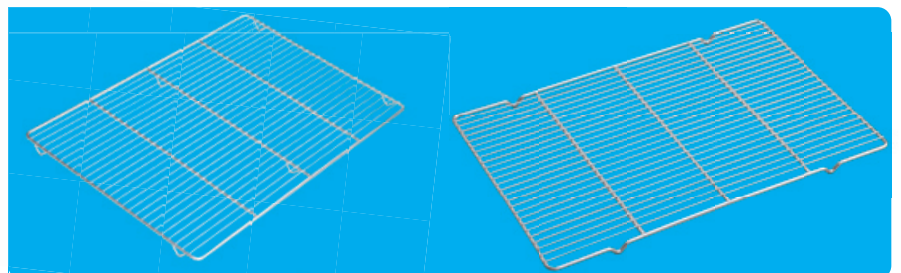

LW07 Stainless steel truss net
 Size: 600×400×25
 Material: Φ6mm Φ4mm Φ2.3mm
 Surface: Electrolytic polishing

LW08 Stainless steel truss net
 Size: 400×600×25
 Material: Φ6mm Φ2.3mm
 Surface: Electrolytic polishing

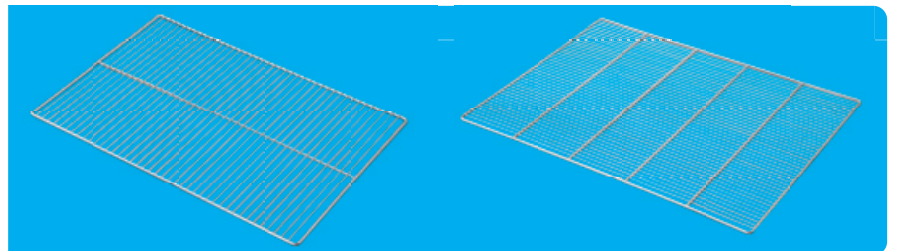

LW10 Dry net
 Size: 640×450×8
 Material: Φ6mm Φ2.3mm
 Surface: Electrolytic polishing

KW11 Dry net
 Size: 600×800×8
 Material: Φ6mm Φ2.3mm
 Surface: Electrolytic polishing



Baking category- Oven Series

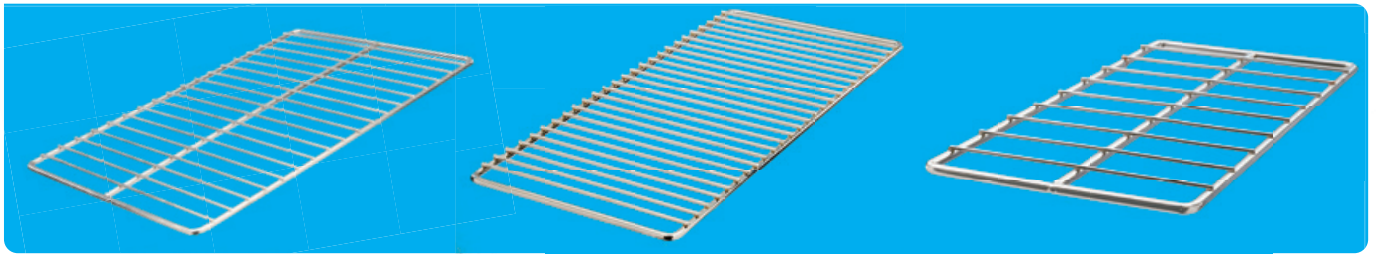

KX01 Oven rack layer

Size: 575×388

Material: Φ8mm Φ4mm

Surface: Nickelage

KX02 Oven rack layer

Size: 695×310

Material: Φ10mm Φ6mm

Surface: Nickelage

KX03 Oven rack layer

Size: 439×210

Material: Φ8mm Φ3mm

Surface: Nickelage

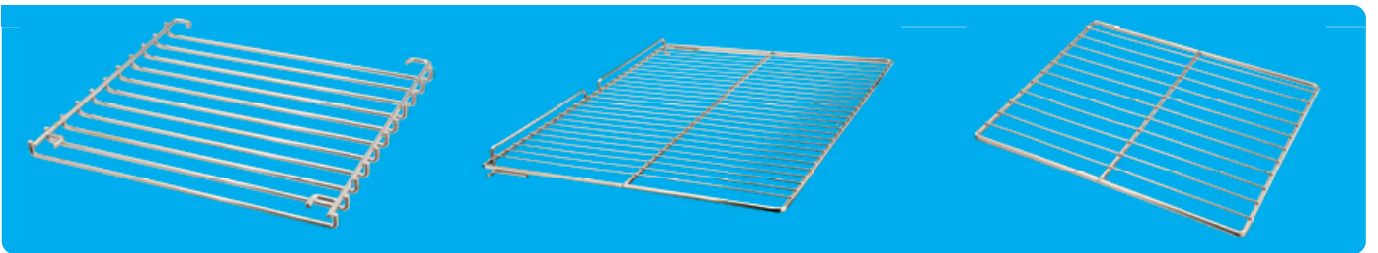

KX04 Oven rack layer

Size: 436×497×24

Material: Φ8mm

Surface: Nickelage

KX05 Oven rack layer

Size: 713×535×47

Material: Φ8mm Φ4mm Φ3mm

Surface: Nickelage

KX06 Oven rack layer

Size: 345×345

Material: Φ8mm Φ3mm

Surface: Nickelage



KX07 Baking rack

Size: 660×525×48

Material: Φ10mm Φ6mm Φ5mm

Surface: Nickelage

KX08 Baking rack

Size: 500×525×48

Material: Φ10mm Φ6mm Φ5mm

Surface: Nickelage

KX09 Baking box slide track

Size: 470×248×40

Material: Φ5mm

Surface: Electro Polishing for Stainless Steel



KX10 Baking rack

Size: 475×475×22

Material: Φ5mm Φ3mm

Surface: Stainless steel

KX11 Baking rack

Size: 374×310×28

Material: Φ5mm Φ3mm

Surface: Stainless steel

KX12 Baking box slide track

Size: 470×248×40

Material: Φ5mm

Surface: Electro Polishing for Stainless Steel

> Baking category- Oven Series

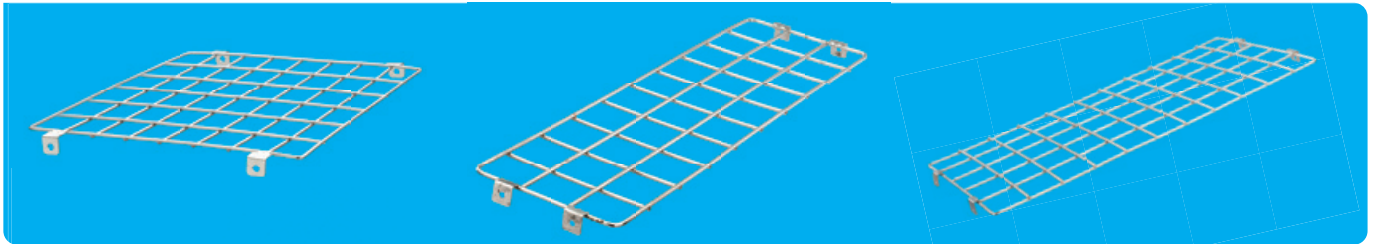

KL01 Downdraft network
 Size: 335×242.5
 Material: Φ4mm
 Surface: Electrolytic polishing

KL02 Downdraft network
 Size: 518×164
 Material: Φ4mm
 Surface: Electrolytic polishing

KL03 Downdraft network
 Size: 106×264
 Material: Φ4mm
 Surface: Electrolytic polishing

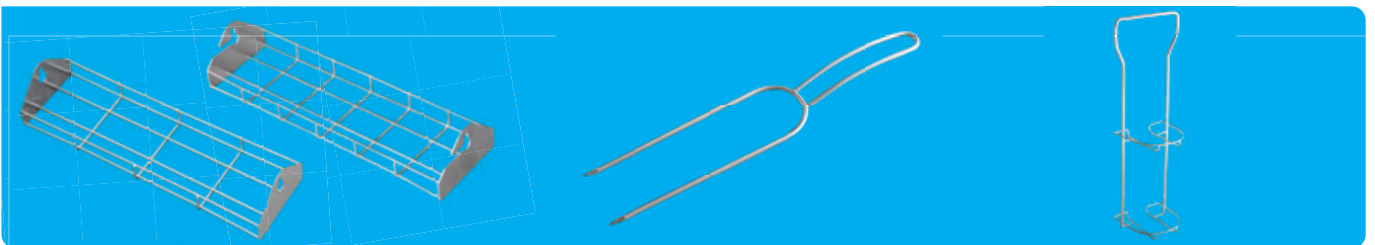

KL-04 Grilled Sweet Potato Rack
 Size: 365×110×72
 Material: Φ2.5mm
 Surface: Electrolytic polishing

KL-05 Tart Rack
 Size: 242×67
 Material: SS304 Φ5mm
 Surface: Electrolytic polishing

KL-06 Roasted Pear Rack
 Size: 372×125
 Material: Φ5mm Φ2.5mm
 Surface: Electrolytic polishing

> Section 2: Food Machinery Series

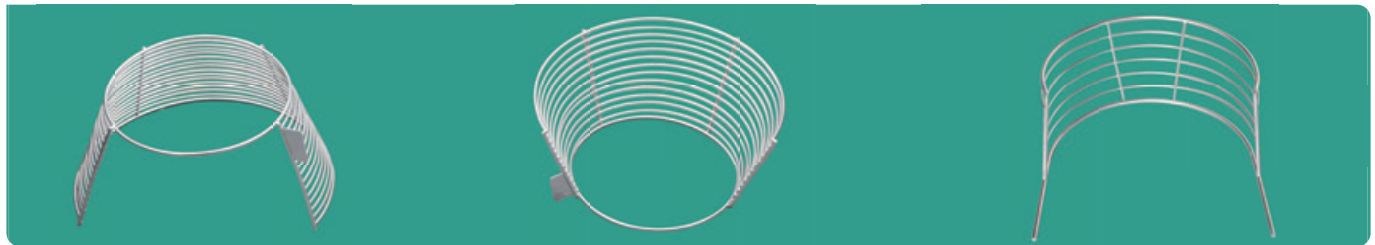

SP-01 BP30 Shield
 Size: 236×360×175
 Material: Φ6mm Φ4mm
 Surface: Electrolytic polishing

SP-02 BP20 Shield
 Size: 236×330×152
 Material: Φ6mm Φ4mm
 Surface: Electrolytic polishing

SP-03 Mixer shield
 Size: 730×530×140
 Material: Φ10mm Φ6mm
 Surface: Electrolytic polishing

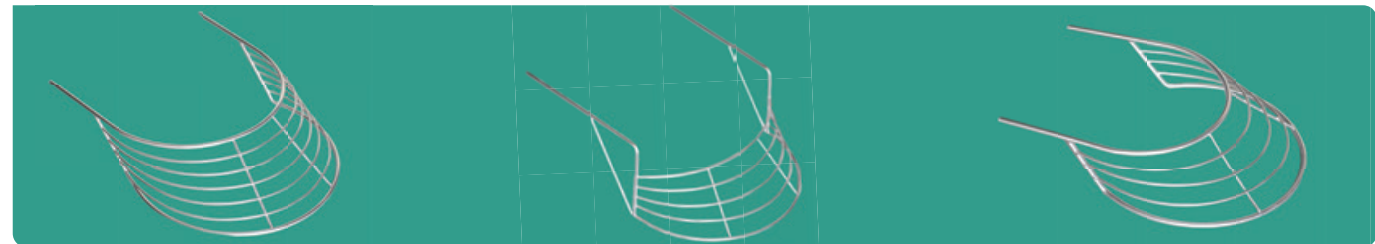

SP-04 Mixer shield
 Size: 680×500×140
 Material: Φ10mm Φ6mm
 Surface: Electrolytic polishing

SP-05 Mixer shield
 Size: 565×393×180
 Material: Φ8mm Φ6mm
 Surface: Electrolytic polishing

SP-06 Mixer shield
 Size: 530×340×110
 Material: Φ10mm Φ6mm
 Surface: Electrolytic polishing



Section 3: Barbecue Stove and Barbecue Mesh Series

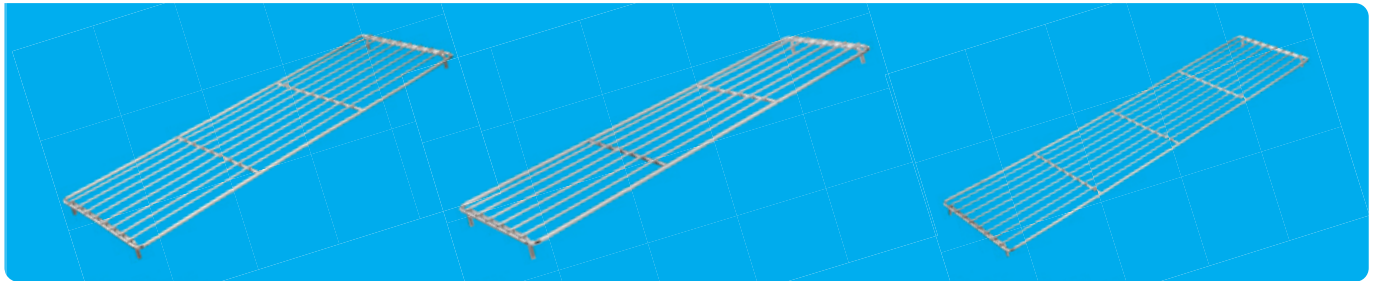

SK-01 BBQ grill
Size: 590×280
Material: Φ5mm Φ4mm
Surface: Chromeplate;Electrolytic polishing

SK-02 BBQ grill
Size: 590×220
Material: Φ5mm Φ4mm
Surface: Chromeplate;Electrolytic polishing

SK-03 BBQ grill
Size: 840×220
Material: Φ5mm Φ4mm
Surface: Chromeplate;Electrolytic polishing

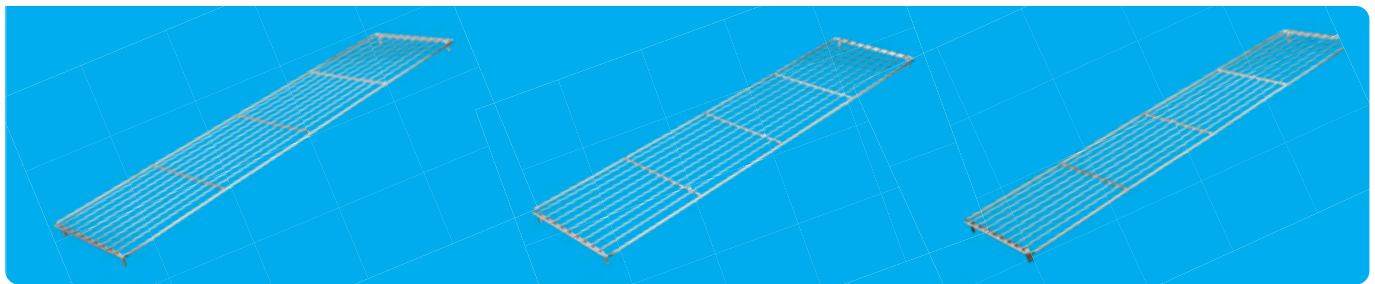

SK-04 BBQ grill
Size: 890×200
Material: Φ5mm Φ4mm
Surface: Chromeplate;Electrolytic polishing

SK-05 BBQ grill
Size: 890×280
Material: Φ5mm Φ4mm
Surface: Chromeplate;Electrolytic polishing

SK-06 BBQ grill
Size: 890×240
Material: Φ5mm Φ4mm
Surface: Chromeplate;Electrolytic polishing

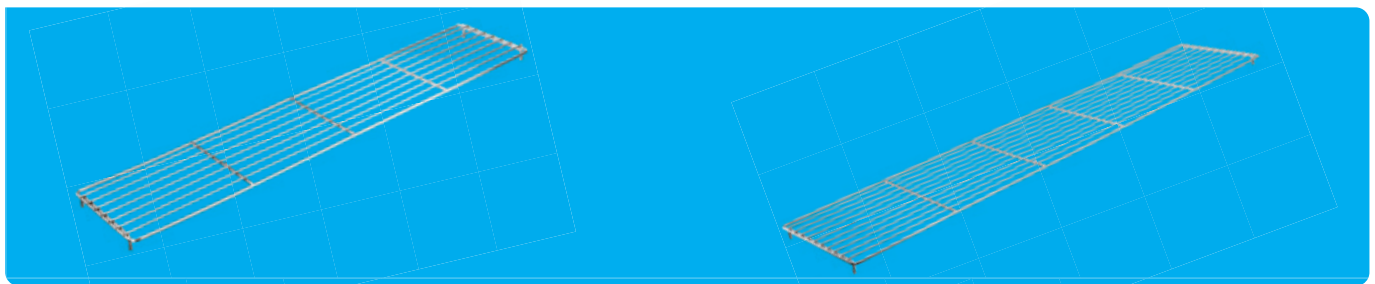

SK-07 BBQ grill
Size: 890×220
Material: Φ5mm Φ4mm
Surface: Chromeplate;Electrolytic polishing

SK-08 BBQ grill
Size: 1190×240
Material: Φ5mm Φ4mm
Surface: Chromeplate;Electrolytic polishing

Model	Size	Model	Size	Model	Size	Model	Size	Model	Size
70oven	440×140	90oven	590×140	1.2moven	890×140	1.5moven	1190×140	2moven	840×140
70oven	440×160	90oven	590×160	1.2moven	890×160	1.5moven	1190×160	2moven	840×160
70oven	440×180	90oven	590×180	1.2moven	890×180	1.5moven	1190×180	2moven	840×180
70oven	440×200	90oven	590×200	1.2moven	890×200	1.5moven	1195×200	2moven	840×200
70oven	440×220	90oven	590×220	1.2moven	895×220	1.5moven	1195×220	2moven	840×220
70oven	440×240	90oven	590×240	1.2moven	890×240	1.5moven	1195×240	2moven	840×240
70oven	440×280	90oven	590×280	1.2moven	890×280	1.5moven	1195×280	2moven	840×280
								1.8moven	90 grill+1.2m grill

Section 4: Drug Cooling Cabinet Series

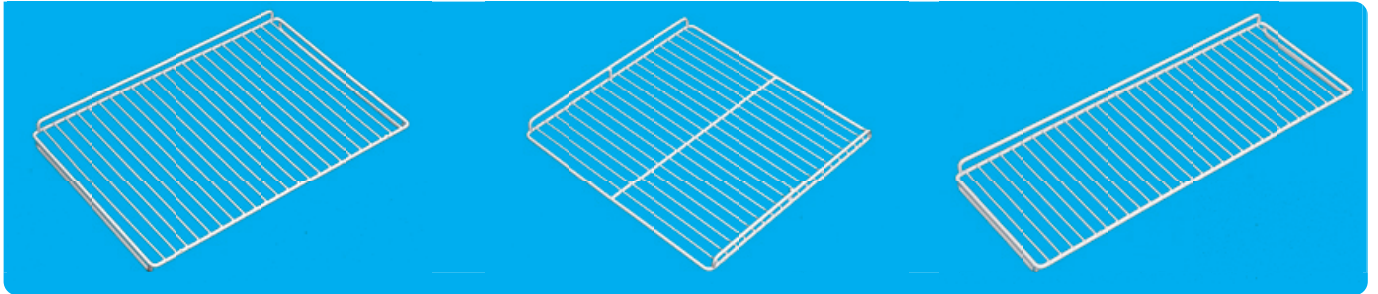

YY-01 Pharmacy shelf
 Size: 324×481
 Material: Φ5mm Φ2.3mm
 Surface: PE (White)

YY-02 Pharmacy shelf
 Size: 406×387
 Material: Φ5mm Φ2.3mm
 Surface: PE (White)

YY-03 Pharmacy shelf
 Size: 625×234
 Material: Φ5mm Φ2.3mm
 Surface: PE (White)

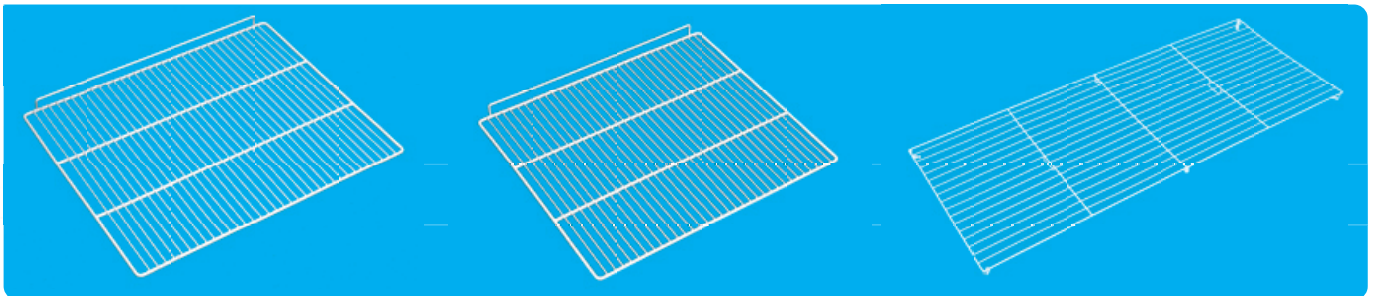

YY-04 Pharmacy shelf
 Size: 590×480
 Material: Φ5mm Φ2.3mm
 Surface: PE (White)

YY-05 Pharmacy shelf
 Size: 530×480
 Material: Φ5mm Φ2.3mm
 Surface: PE (White)

YY-06 Back guard net of Pharmacy
 Size: 1200×480
 Material: Φ5mm Φ2.3mm
 Surface: PE (White)

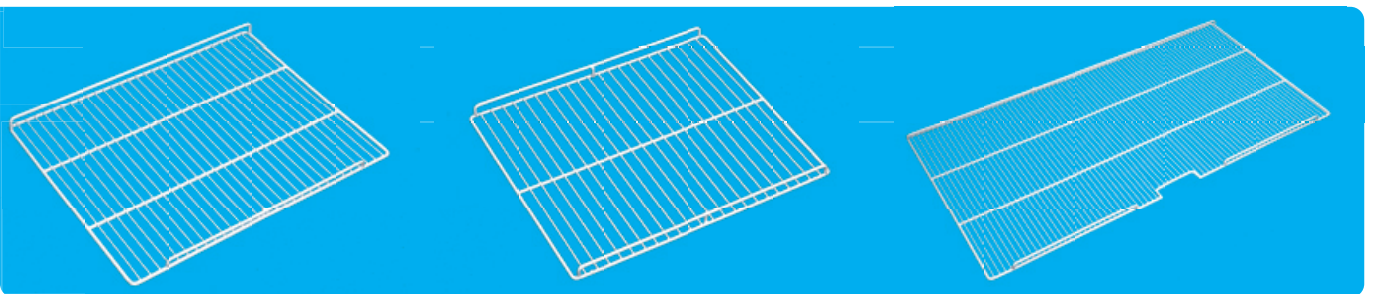

YY-07 Pharmacy shelf
 Size: 497×621
 Material: Φ5mm Φ2.3mm
 Surface: PE (White)

YY-08 Pharmacy shelf
 Size: 496×477
 Material: Φ5mm Φ2.3mm
 Surface: PE (White)

YY-09 Pharmacy shelf
 Size: 1158×570×38
 Material: Φ7mm Φ2.3mm
 Surface: PE (White)



Section 5: Island Cabinet Combination Grid Series

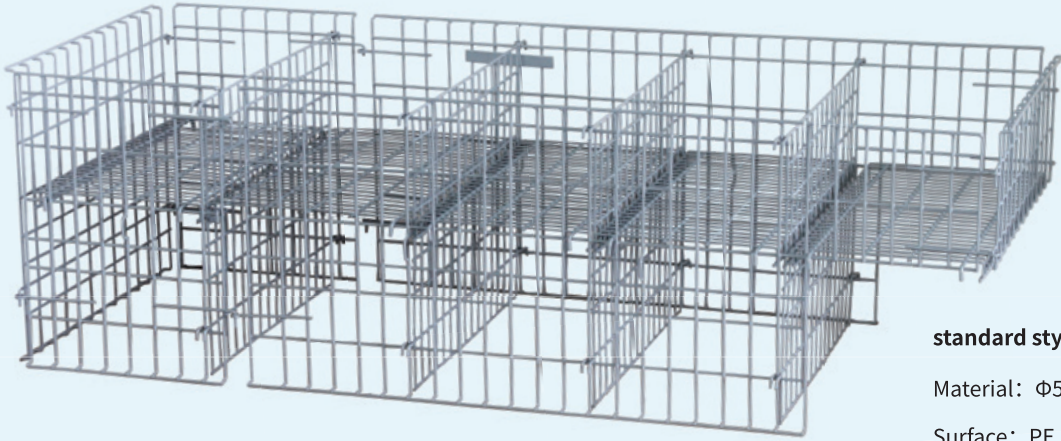

standard style

Material: Φ 5mm Φ 4mm Φ 3mm

Surface: PE (grey)

● Style 01-1500

● Style 03-2100

● End Socket-1900

● Style 02-1800

● Style 04-2500

● End Socket-2100

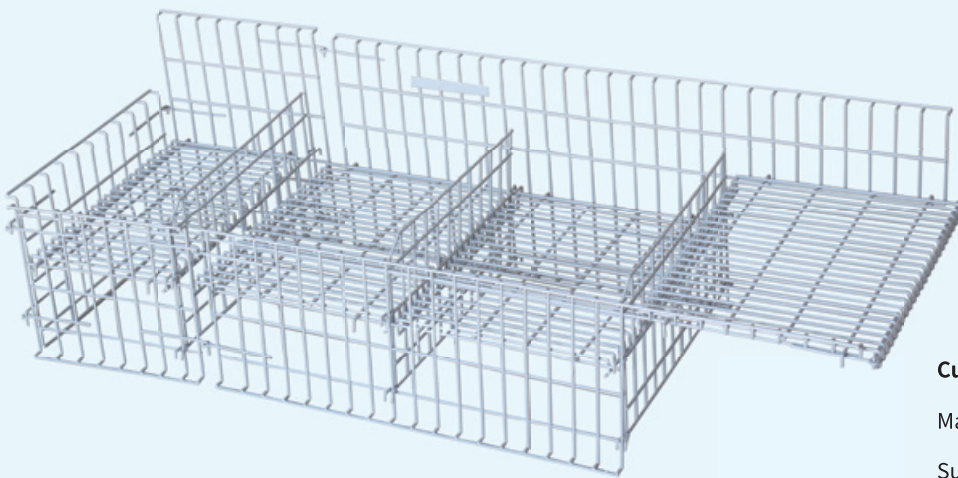

Customized Style

Material: Φ 5mm Φ 4mm Φ 3mm

Surface: PE (grey)

● Style 01-1500

● Style 03-2100

● End Socket-1900

● Style 02-1800

● Style 04-2500

● End Socket-2100

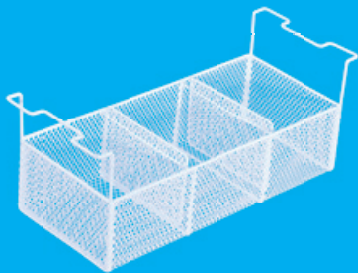

● LG-31 Island shelf net basket

Size: 620×270×265

Material: Φ 5mm Φ 2.3mm Surface: PE (White)

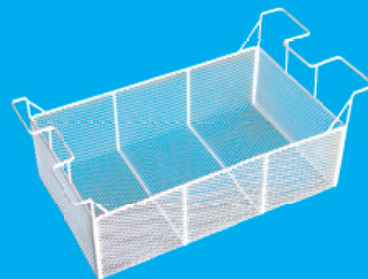

● LG-32 Island shelf net basket

Size: 690×310×303

Material: Φ 5mm Φ 2.3mm Surface: PE (White)

Section 6: Refrigerator Series - Shelving

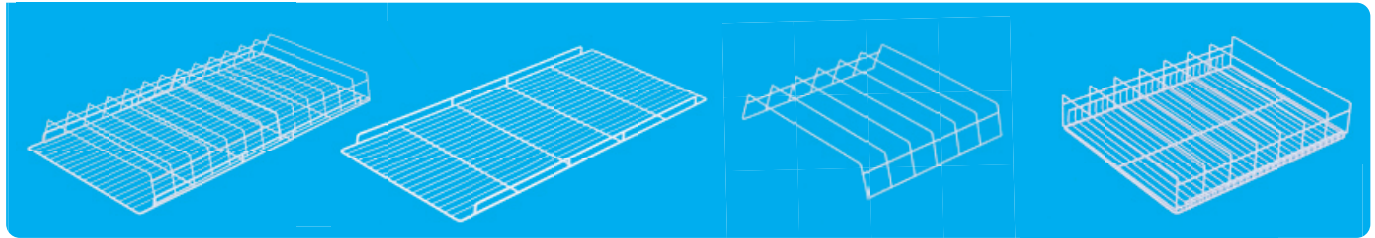

<p>● LG-01 Beverage cabinet shelf (set)</p> <p>Size: 1080×490</p> <p>Material: Φ6.5mm Φ3mm</p> <p>Surface: PE (White)</p>	<p>● LG-02 shelf</p> <p>Size: 1080×490</p> <p>Material: Φ6.5mm Φ3mm</p> <p>Surface: PE (White)</p>	<p>● LG-03 Partition grid</p> <p>Size: 530×490×80</p> <p>Material: Φ3mm</p> <p>Surface: PE (White)</p>	<p>● LG-04 Beverage cabinet shelf (set)</p> <p>Size: 497×621</p> <p>Material: Φ6mm Φ2.8mm</p> <p>Surface: PE ()</p>
--	---	---	---

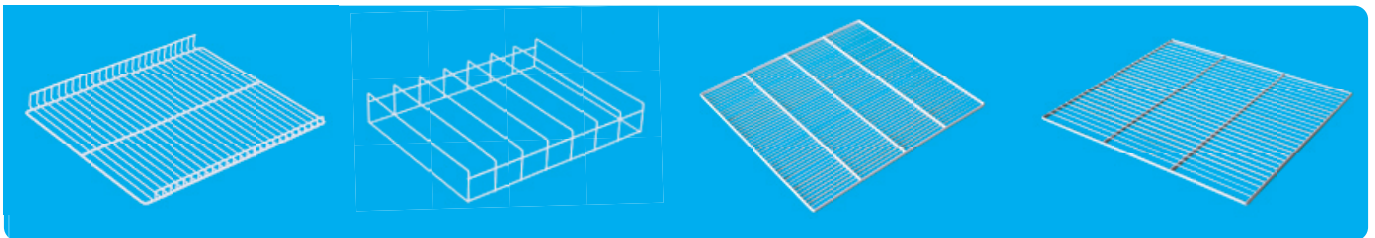

<p>● LG-05 shelf</p> <p>Size: 497×621</p> <p>Material: Φ6mm Φ2.8mm</p> <p>Surface: PE (White)</p>	<p>● LG-06 Partition grid</p> <p>Size: 497×621×80</p> <p>Material: Φ4mm</p> <p>Surface: PE (White)</p>	<p>● LG-07 Band iron frame</p> <p>Size: 500×635</p> <p>Material: 10×3 band iro Φ2.5mm</p> <p>Surface: PE (White)</p>	<p>● LG-08 Fresh food cabinet shelf</p> <p>Size: 500×660</p> <p>Material: 10×3 band iro Φ2.0mm</p> <p>Surface: PE (White)</p>
--	---	---	--

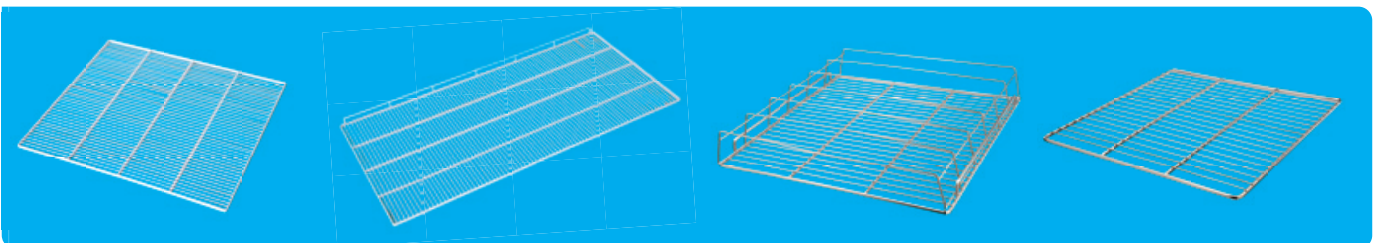

<p>● LG-09 Fresh food cabinet shelf</p> <p>Size: 600×660</p> <p>Material: 10×3 band iro Φ2.0mm</p> <p>Surface: PE (White)</p>	<p>● LG-10 Double-door beverage rack</p> <p>Size: 1080×530</p> <p>Material: 10×3 band iro Φ2.0mm</p> <p>Surface: PE (White)</p>	<p>● LG-11 Stainless steel beverage cabinet shelf (set)</p> <p>Size: 497×621</p> <p>Material: Φ6mm Φ4mm Φ3mm</p> <p>Surface: Electrolytic polishing</p>	<p>● LG-12 Stainless shelf</p> <p>Size: 530×520</p> <p>Material: Φ8mm Φ3mm</p> <p>Surface: Electrolytic polishing</p>
--	--	--	--

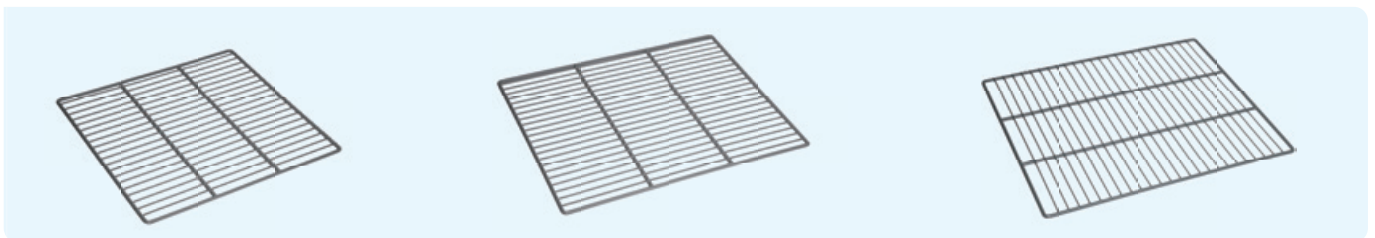

<p>● LG-13 shelf</p> <p>Size: 530×570</p> <p>Material: Φ8mm Φ3mm</p> <p>Surface: PE (grey)</p>	<p>● LG-14 shelf</p> <p>Size: 530×645</p> <p>Material: Φ8mm Φ3mm</p> <p>Surface: PE (grey)</p>	<p>● LG-15 shelf</p> <p>Size: 670×570</p> <p>Material: Φ8mm Φ3mm</p> <p>Surface: PE (grey)</p>
---	---	---



Refrigerator Series - Shelving

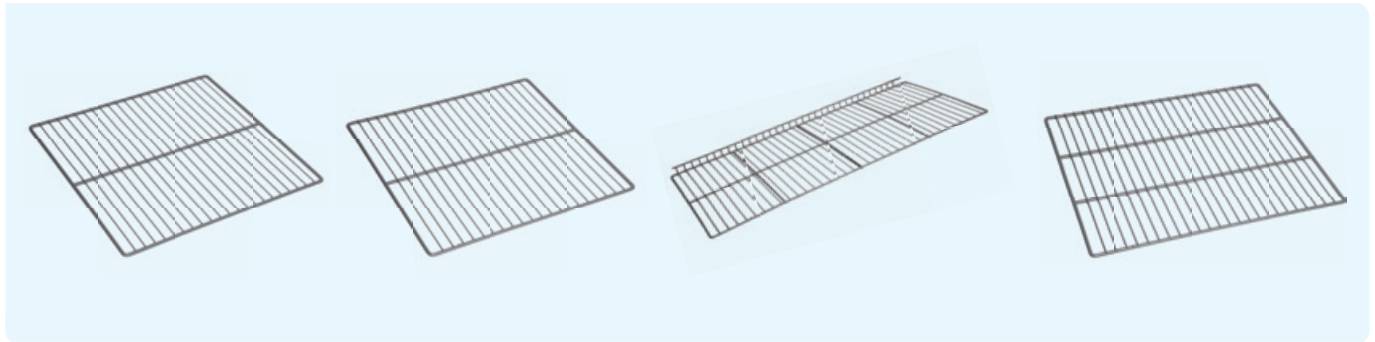

● LG-16 Four door shelf

Size: 530×520

Material: Φ7mm Φ2mm

Surface: PE (grey)

● LG-17 Four door shelf

Size: 550×540

Material: Φ7mm Φ2mm

Surface: PE (grey)

● LG-18 Four door shelf

Size: 1080×530

Material: Φ5mm Φ2mm

Surface: PE (grey)

● LG-19 Six door shelf

Size: 670×570

Material: Φ7mm Φ2mm

Surface: PE (grey)

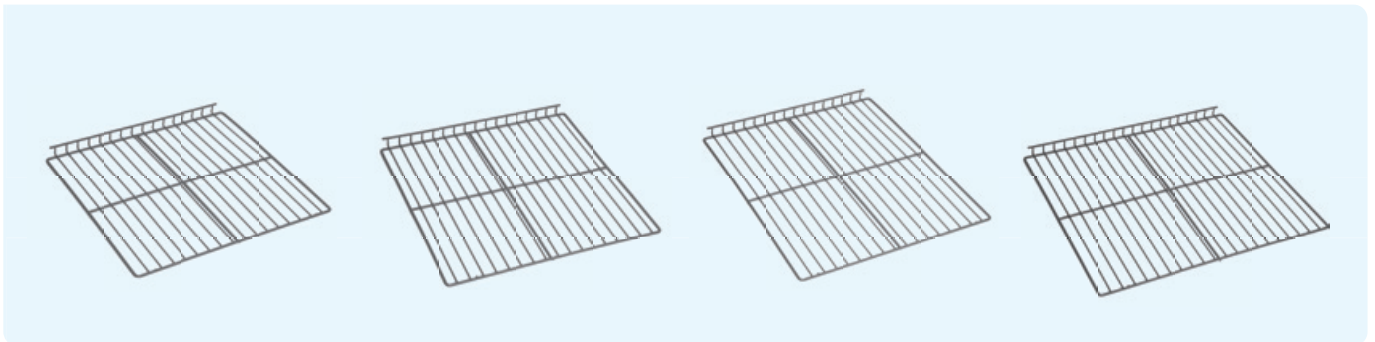

● LG-20 Worktable shelf

Size: 510×390

Material: Φ5mm Φ2.5mm

Surface: PE (grey)

● LG-21 Worktable shelf

Size: 510×490

Material: Φ5mm Φ2.5mm

Surface: PE (grey)

● LG-22 Worktable shelf

Size: 510×590

Material: Φ5mm Φ2.5mm

Surface: PE (grey)

● LG-23 Worktable shelf

Size: 660×490

Material: Φ5mm Φ2.5mm

Surface: PE (grey)

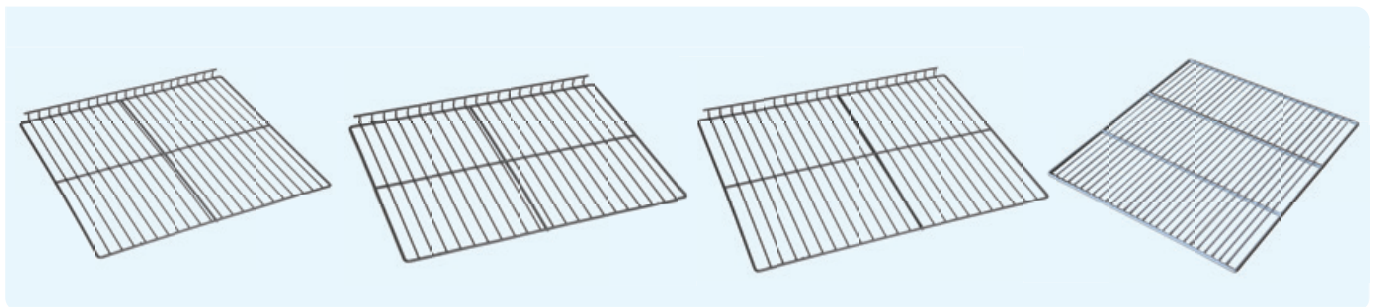

● LG-24 Worktable shelf

Size: 660×590

Material: Φ5mm Φ2.5mm

Surface: PE (grey)

● LG-25 Worktable shelf

Size: 730×490

Material: Φ5mm Φ2.5mm

Surface: PE (grey)

● LG-26 Worktable shelf

Size: 730×590

Material: Φ5mm Φ2.5mm

Surface: PE (grey)

● LG-27 Band iron frame

Size: 500×510

Material: 10×3 band iron Φ2.5mm

Surface: PE (grey)

Refrigerator Series - Refrigerator Guard

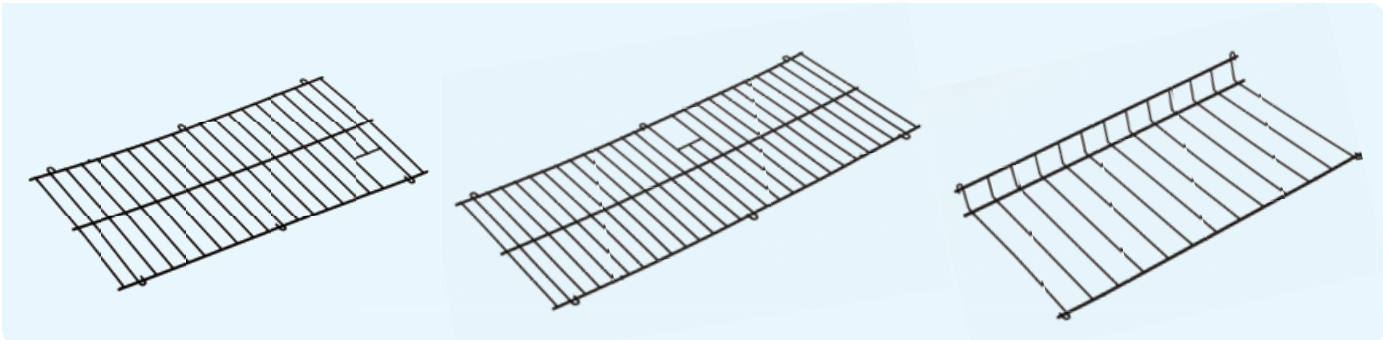

HW-01 Worktable shield

Size: 590×312
 Material: Φ3mm
 Surface: PE (black)

HW-02 Series B Worktable shield

Size: 630×310
 Material: Φ3mm
 Surface: PE (black)

HW-03 Upright door shield

Size: 595×340
 Material: Φ4mm Φ2mm
 Surface: PE (black)

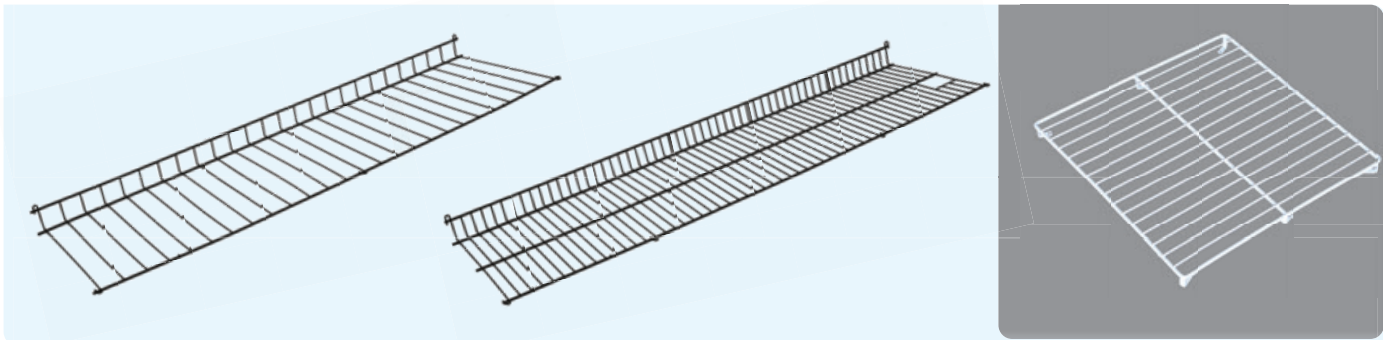

HW-04 Four door shield

Size: 1195×340
 Material: Φ4mm Φ2mm
 Surface: PE (black)

HW-05 Series B four doors shield

Size: 1208×345
 Material: Φ4mm Φ2mm
 Surface: PE (black)

HW-06 Refrigerator shield

Size: 483×590
 Material: Φ6mm Φ3mm
 Surface: PE (White)

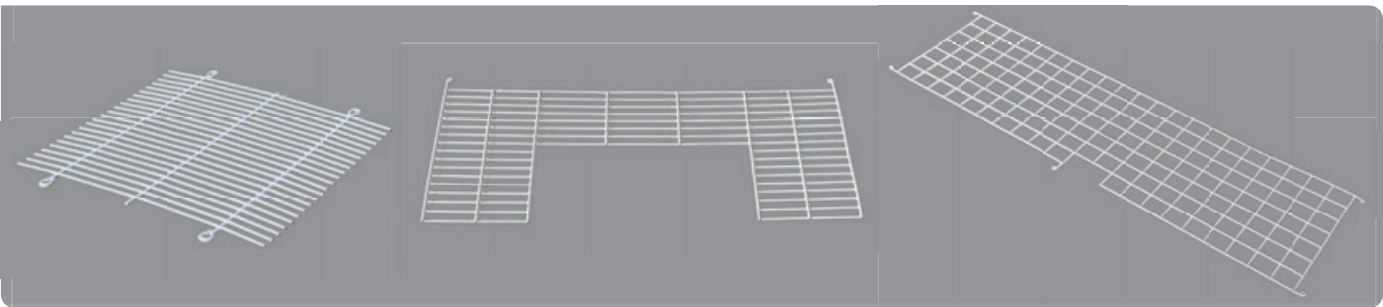

HW-07 Rear gear guard of the worktable cabinet

Size: 325×298
 Material: Φ3mm Φ2mm
 Surface: PE (White)

HW-08 Rear gear guard

Size: 808×353
 Material: Φ3mm
 Surface: PE (White)

HW-09 Rear gear guard

Size: 1205×345
 Material: Φ2mm
 Surface: PE (White)



Refrigerator Series - Condenser

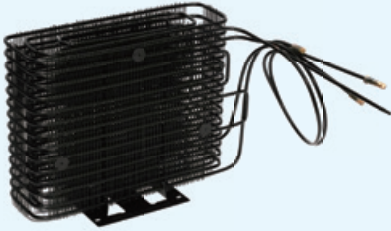

LNQ-01
Refrigerator protective net

Size: 394×296

Material: Φ6 Copper-plated pipe
Φ1.2mm

Surface: Electrotic paint

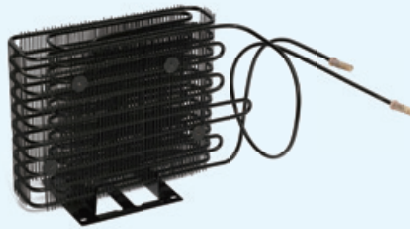

LNQ-02
Single-system condenser

Size: 316×243 (5 layers)

Material: Φ6Copper-plated pipe
Φ1.2mm

Surface: Electrotic paint

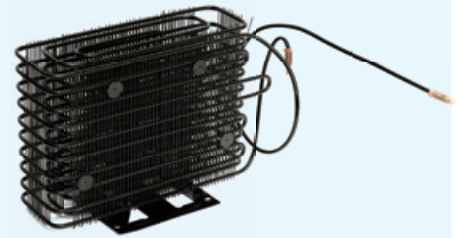

LNQ-03
Single-system condenser

Size: 352×243

Material: Φ6Copper-plated pipe
Φ1.2mm

Surface: Electrotic paint

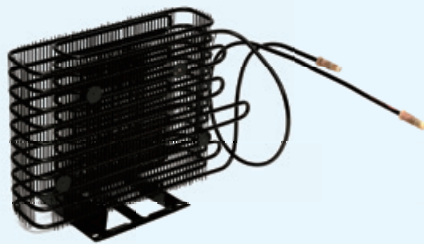

LNQ-04
Single-system condenser

Size: 316×243 (四层 4 layers)

Material: Φ6Copper-plated pipe
Φ1.2mm

Surface: Electrotic paint



LNQ-05 Small No. 5 Workshop -
Condenser

Size: 245×205×225

Material: Φ4.76Copper-plated
pipe Φ1.2mm

Surface: Electrotic paint

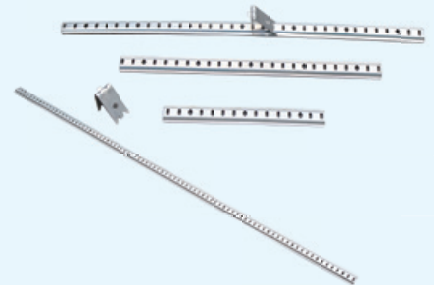

LGTT
Refrigerator Elevator

Size: 562/1062/1189/1871

Material: Stainless

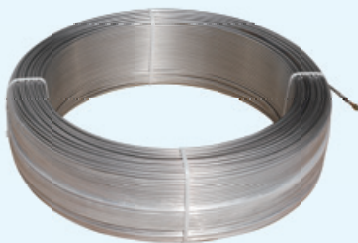

ZFQPG
Evaporator stainless steel pan coil

Size: Φ7x0.4mm

Material: 304

Surface: Stainless Steel Original Color



ZFQPG Evaporator stainless steel
copper-plated coil

Size: Φ7x0.4mm

Material: 304

Surface: Copper plated color



ZFQPG
pressure retaining valve

▶ Section 7: Dishwasher series

Product Material: High quality stainless steel materials such as 201, 304, 316, 316L, etc
 Product specifications: Customized according to customer requirements
 Product use: Can be used for disinfection and sterilization of items, ultrasonic cleaning, storage and application, etc

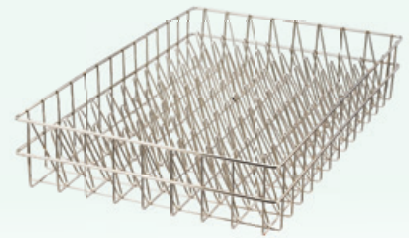

● XW-01 Dishwasher basket

Size: 730×450×120
 Material: Φ6mm Φ3mm
 Surface: Electrolytic polishing

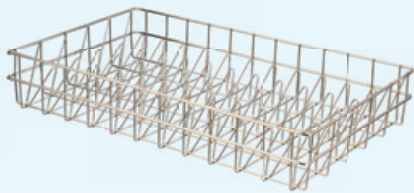

● XW-02 Dishwasher basket

Size: 730×450×120
 Material: Φ6mm Φ3mm
 Surface: Electrolytic polishing

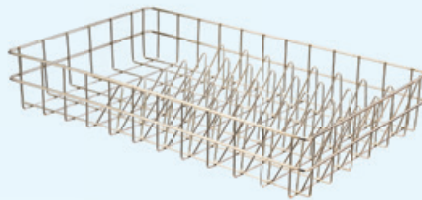

● XW-03 Dishwasher basket

Size: 730×450×120
 Material: Φ6mm Φ3mm
 Surface: Electrolytic polishing

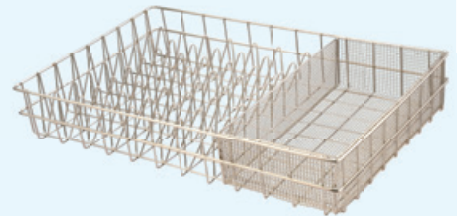

● XW-04 Dishwasher basket

Size: 730×450×120
 Material: Φ6mm Φ3mm
 rayon mesh1×5.5
 Surface: Electrolytic polishing



● XW-05 Dishwasher rack (wall-mounted)

Size: 600×520×100
 Material: Φ8mm
 Surface: Electrolytic polishing

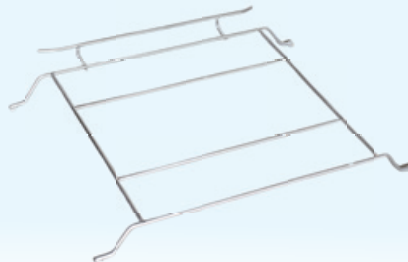

● XW-06 Dishwasher rack (tray-type)

Size: 607×486×60
 Material: Φ7mm
 Surface: Electrolytic polishing

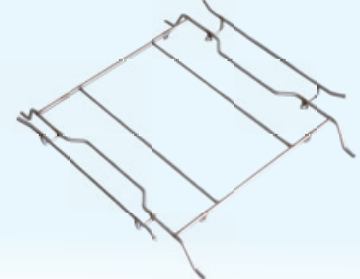

● XW-07 Dishwasher rack (tray-type)

Size: 600×525×60
 Material: Φ8mm
 Surface: Electrolytic polishing



Section 8: Disinfection Cabinet Series



XD-01
Disinfection basket
Size: 480×410×195
Material: Φ6mm Φ4mm
Surface: Electrolytic polishing

XD-02 Series B cart disinfection basket
Size: 500×460×260
Material: Φ6mm Φ4mm Φ3mm
Surface: Electrolytic polishing

XD-03 Disinfection cabinet deep basket
Size: 560×405×260
Material: Φ6mm Φ3.8mm Φ2.8mm
Surface: Electrolytic polishing

XD-04 Disinfection cabinet deep basket
Size: 560×405×100
Material: Φ5mm Φ3.5mm Φ3mm Φ2.3mm
Surface: Electrolytic polishing

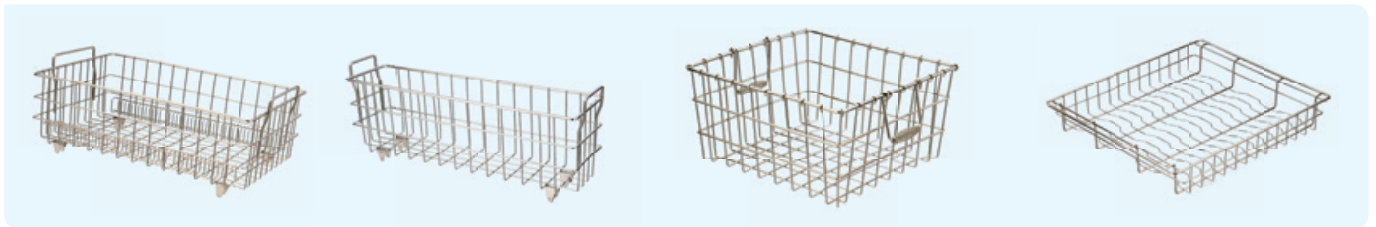

XD-05
Series A cart basket (large)
Size: 630×400×190
Material: Φ6mm Φ4mm Φ3mm
Surface: Electrolytic polishing

XD-06
Series A cart basket (small)
Size: 630×160×190
Material: Φ6mm Φ4mm Φ3mm
Surface: Electrolytic polishing

XD-07
Basket
Size: 391×316×200
Material: Φ6mm Φ4mm Φ3mm
Surface: Electrolytic polishing

XD-08 Variable Frequency Series B Disinfection Basket
Size: 600×460×100
Material: Φ6mm Φ4mm Φ3mm
Surface: Electrolytic polishing

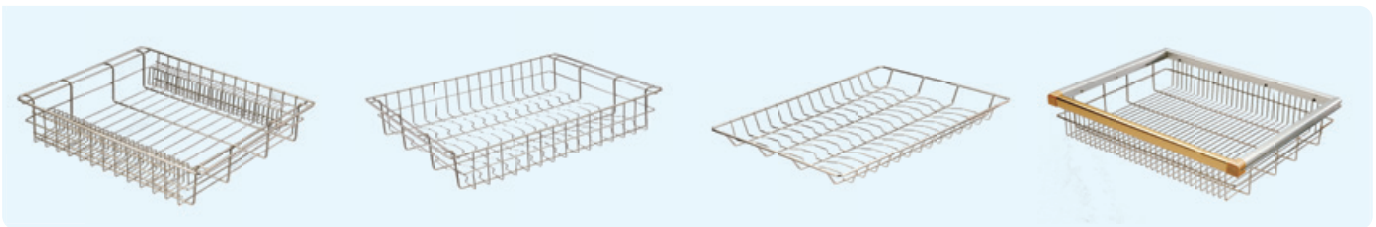

XD-09 Variable Frequency Series B Disinfection Basket
Size: 600×460×130
Material: Φ6mm Φ4mm Φ3mm
Surface: Electrolytic polishing

XD-10 Disinfection cabinet deep basket
Size: 558×390×70
Material: Φ6mm Φ4mm Φ2.5mm
Surface: Electrolytic polishing

XD-11 Light wave disinfection basket
Size: 525×395×40
Material: Φ5mm Φ4mm Φ2mm
Surface: Electrolytic polishing

XD-12 Frequency-modulated disinfection basket
Size: 573×443×100
Material: Φ3.5mm Φ2.5mm
Surface: Electrolytic polishing

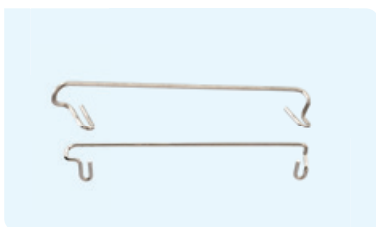

XD-13
Disinfection box support
Size: 375mm
Material: Φ6mm
Surface: Electrolytic polishing

PRODUCTION EQUIPMENT



① Stainless steel pipe production line



② Dip line



③ Welding Machine



④ Dip line



⑤ Gantry welding



⑥ Punch



⑦ Double head XY axis automatic welding



⑧ Bending machine



⑨ 3D bending machine



⑩ 2D butt welding integrated machine



⑪ Butt welding machine



⑫ High speed line adjustment machine



⑬ 2D Wire Bending Machine (for 6-10mm wire)



⑭ CNC TIG Welding Machine

»»» COOPERATIVE PARTNER



Boxing MeiXing Commercial Kitchen Equipment MFG.Co,Ltd

Address: Industrial Park, Zhaibian Village, Hubin Town, Boxing County,

Binzhou City, Shandong Province, China